

WJ15EDGKD-3.5/3.81
PLUG-IN TERMINAL BLOCK



PCB connector
 Rated current: 8 A
 Rated voltage: 300 V
 Wire range: 28-16 AWG
 Pitch: 3.5 mm/3.81 mm
 Connection method: Push-in spring connection



For reference only!version1.0

UL/CUL

Use Group	B	C	D
Rate Voltage [V]	300	-	300
Rated Current [A]	8	-	8
Wire Range [AWG]	28~16		
Dielectric Voltage-Withstand	1.6KV		

IEC

Overvoltage Category	III	III	II
Contamination Class	3	2	2
Rated Voltage [V]	160	160	320
Rated Current [A]	8	8	8
Impulse withstand voltage [KV]	2.5	2.5	2.5
Conductor cross section[solid/flexible] [mm ²]	0.2~1.5		

Material

WJ15EDGKD-3.5/3.81

PLUG-IN TERMINAL BLOCK



Insulation Material	PA66
Flame retardant rating	UL94V-0
Conductor Material	Copper alloy
Plating of conductor surface	Sn plated

Other Data

Pitch/Poles [mm]/[P]	3.5 , 3.81/2-24
Stripping Length [mm]	7~8
Screw/Torque(Max)[N.m]	/
Operating temperature [°C]	-40~+105
Soldering temperature	/
Pin dimensions [mm]	/
PCB Hole Diameter [mm]	/

Dimensions

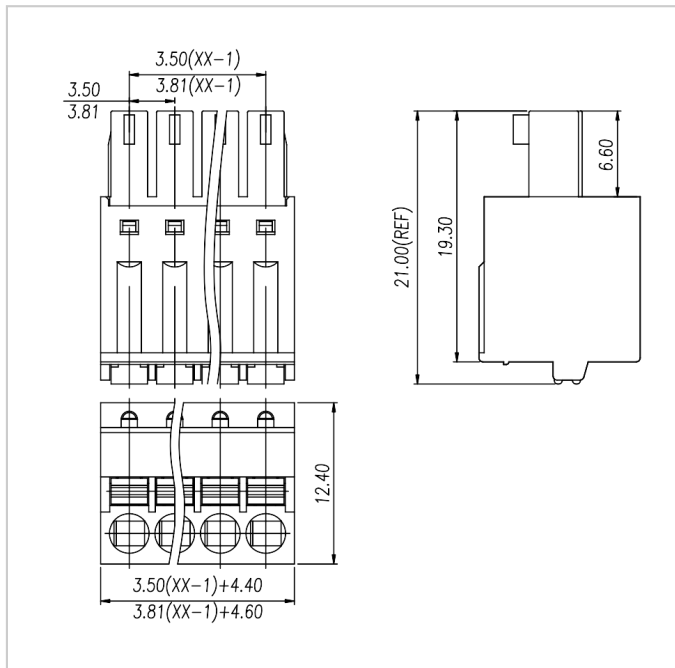

Accessories



[WJ15EDGVC-THR-3.5/3.81](#)

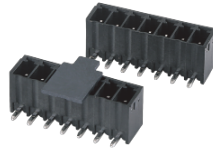

[WJ15EDGRC-THR-3.5/3.81](#)

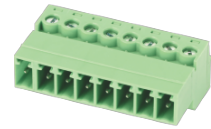

[WJ15EDGKR-3.5/3.81](#)

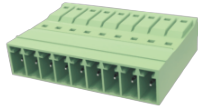

[WJ15EDGKNR-3.5](#)

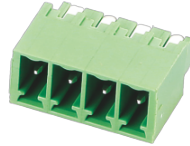

[WJ15EDGVF-3.81](#)



[WJ15EDGGB-3.81](#)

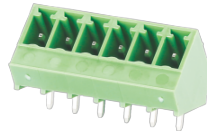

[WJ15EDGLC-3.5/3.81](#)

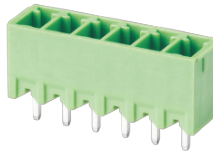

[WJ15EDGVC-3.5/3.81](#)

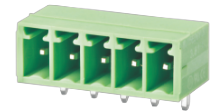

[WJ15EDGRC-3.5/3.81](#)



[WJ15EDGVT-3.5/3.81](#)



[WJ15EDGRT-3.5/3.81](#)



[WJ15EDGVH-3.5/3.81](#)



[WJ15EDGRH-3.5/3.81](#)